

INSTRUCTIONS FOR MOUNTING AND USE

RELFIX 3404003W / 3404003C / 3404003M FLUSH BUTTONS

Dear Customers! Thank you for having chosen Lavinia Boho products.

PRODUCT DESIGNATION

The flush button is designed to complete the installation systems in sanitary facilities of multifunctional buildings.

BEFORE MOUNTING

Read carefully and follow these instructions in order to avoid any injuries and property damage.

Before mounting the flush button shall be stored in an undamaged original package in dry and ventilated location not less than 1 m from heating appliances and protected from direct sunlight. In case of prior unpacking, the flush button shall be reliably packaged again in such a way as to avoid its contamination and damage.

The mounting of the flush button does not require special knowledge or training, but we recommend you to employ qualified mechanical assembly workers. If before starting or during the work you have any questions concerning the given instructions or face any difficulties in performing certain stages of work, please stop the mounting procedure immediately and ask for professional advice.

Some physical efforts are required to clamp the fixing elements. However, avoid excessive physical efforts as you may damage the flush button or the installation system, suffer an injury or property damage. Please be extremely careful while clamping the fixing elements of the flush button.

SUPPLY PACKAGE AND MOUNTING INSTRUCTIONS

If there are any protective films and other packing pieces, remove them from the product before starting mounting works. During mounting of the flush button and the installation system, please follow the precautions usually taken during mechanical assembly work.

For convenient identification, a complete list of components with their images is shown schematically in blocks with a sequential description of the mounting procedure.

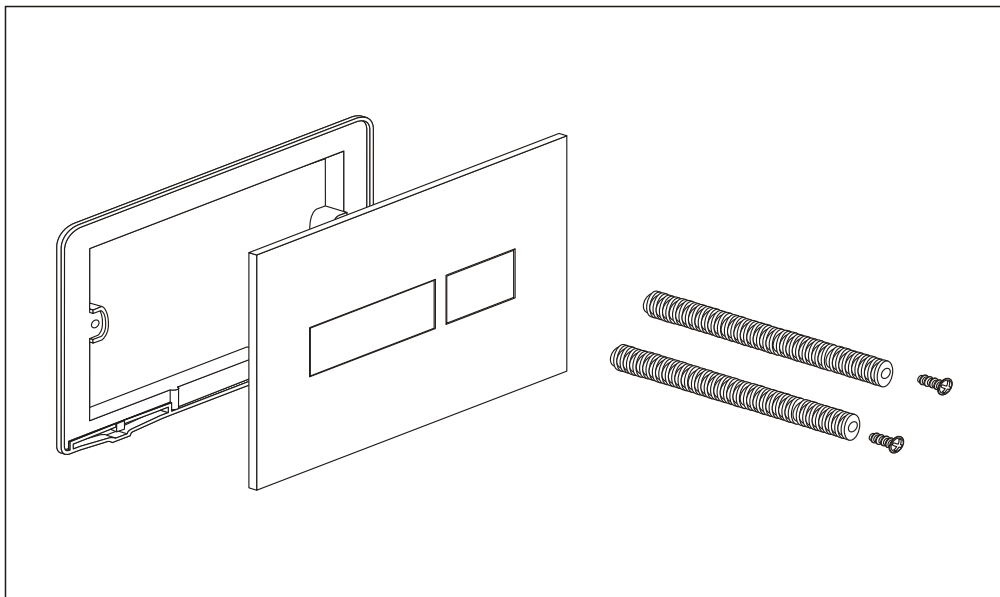

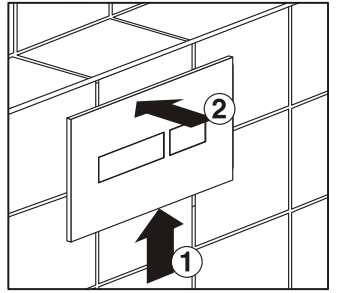
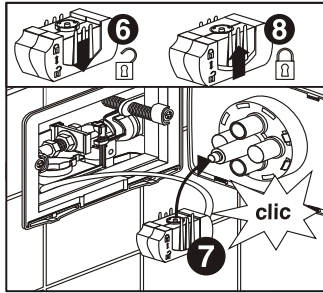
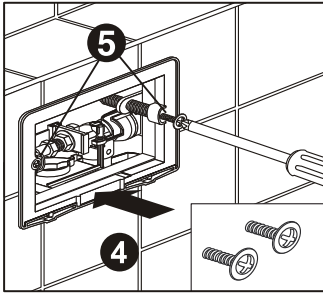
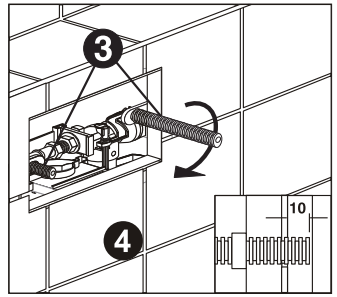
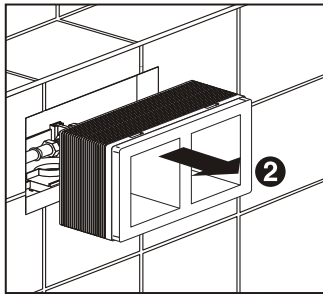
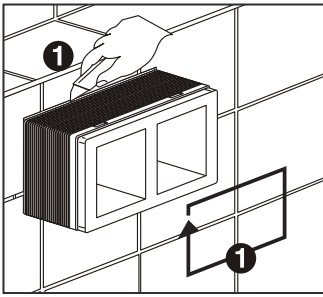

INSTRUCTIONS FOR USE

Check the holding strength of the flush button upon completion of mounting works.
 Use the flush button for intended purpose only: do not put or drop any things on the flush button.
 Do not allow your pets to contact with the flush button.
 Annually check the mounting position and holding strength of the flush button.
 Keep out of direct sunlight.

INSTRUCTIONS FOR CARE

It is recommended to wipe the flush button with a dry or wet cloth (depending on type of contamination) after each use.
 Use warm soapy water to clean the flush button; do not use abrasive, acid, alkaline or other aggressive cleaning agents, different solvents, including organic solvents, as they may damage the product. Do not use hard and wire brushes for cleaning the flush button (or any other cleaning means that may damage the product surface).

TERMS OF WARRANTY

The Manufacturer and the Seller warrant normal operation of the fastening mechanism of the flush button and its usability for the purpose intended within the warranty period.
 Warranty period for the flush button is specified by the Seller in warranty card.
 The Manufacturer and the Seller shall have no warranty obligation (the warranty is cancelled) if any defects are found due to improper mounting, ignoring the instructions for use and care of the flush button.
 The warranty does not cover normal wear and tear.

EXTRA INFORMATION

There are no toxic pollutant emissions from the installation system flush buttons during its mounting and use. Our products have no harmful effect on human organism.
 The flush buttons are not subject to obligatory certification.